

FIG. 1

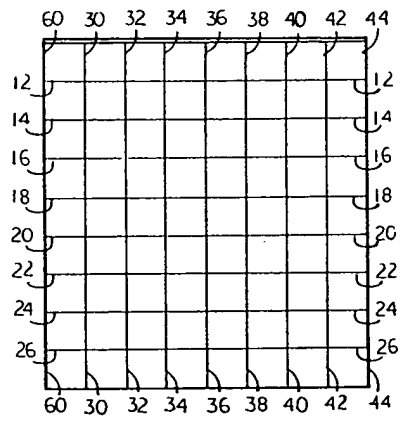

FIG. 1A

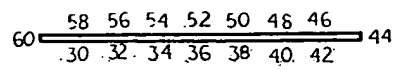

FIG. 1B

2 BOX DESIGN

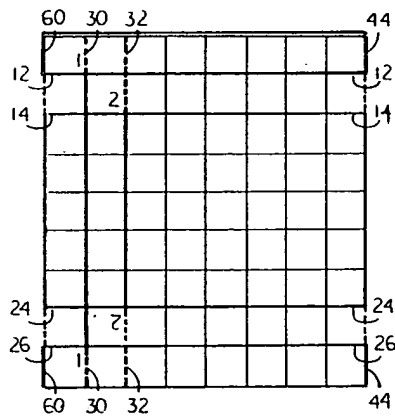

FIG-2

2 BOX DESIGN

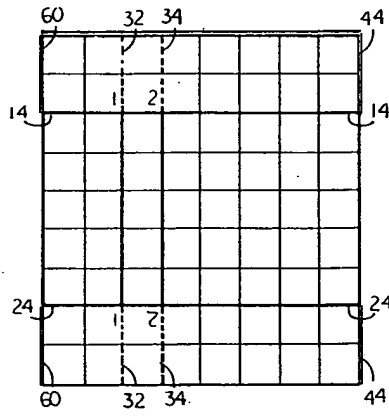

FIG-4

3 BOX DESIGN

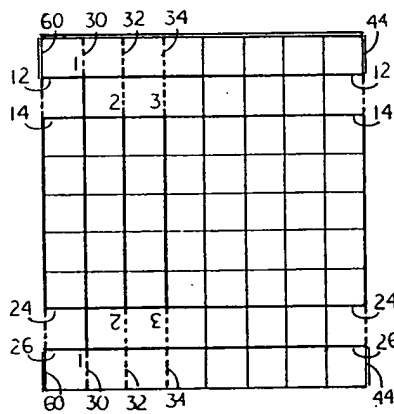

FIG-3

3 BOX DESIGN

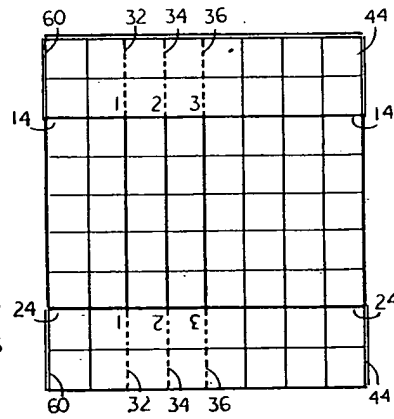

FIG-5

5 BOX DESIGN

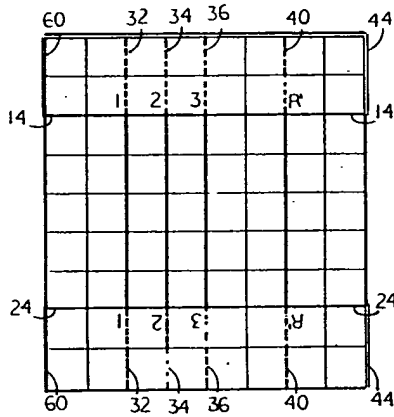

FIG. 6

5 BOX DESIGN

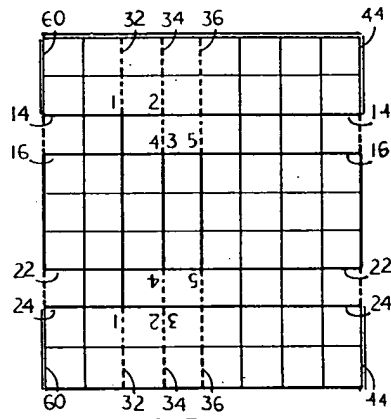

FIG. 7

7 BOX DESIGN

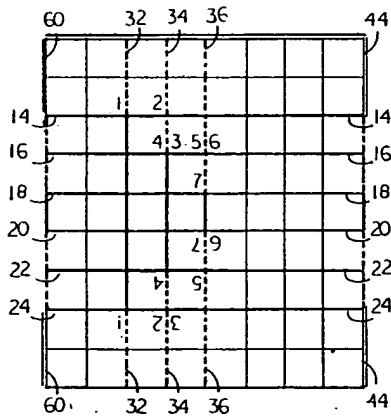

FIG. 8

9 BOX DESIGN

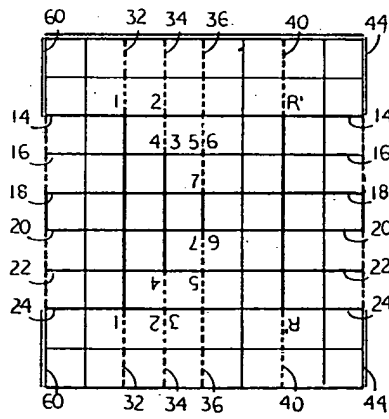

FIG. 9

14 BOX DESIGN

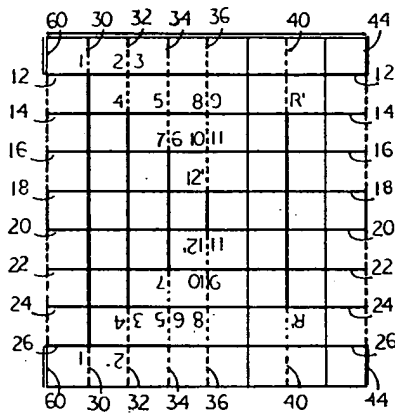

FIG. 10

25 BOX DESIGN

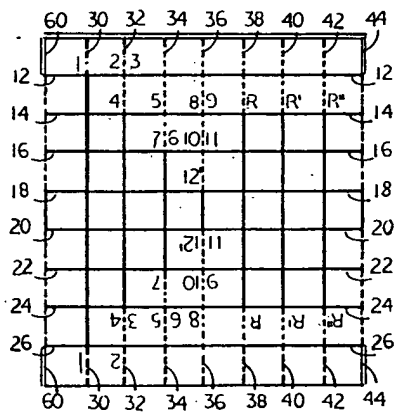

FIG. 11

3IBOX DESIGN

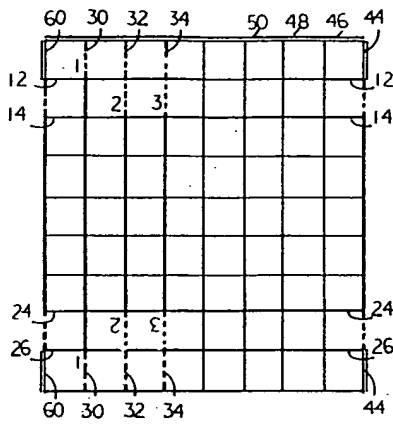

FIG. 3

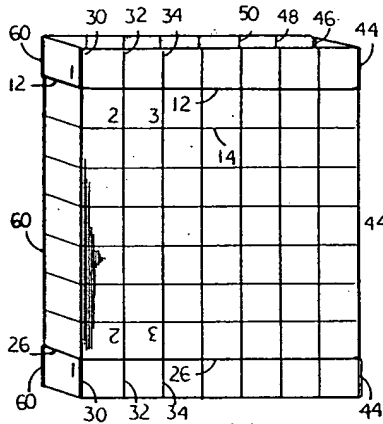

FIG. 3A1

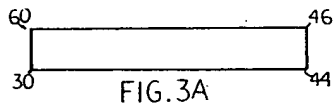

FIG. 3A

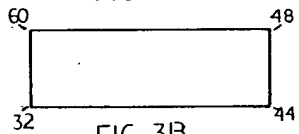

FIG. 3B

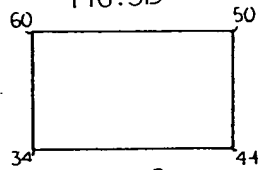

FIG. 3C

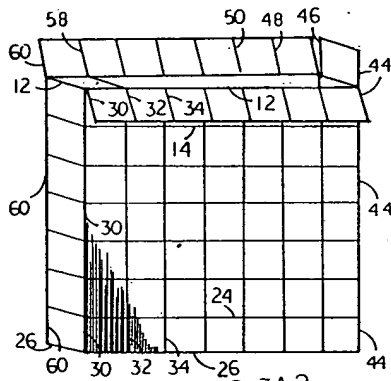

FIG. 3A2

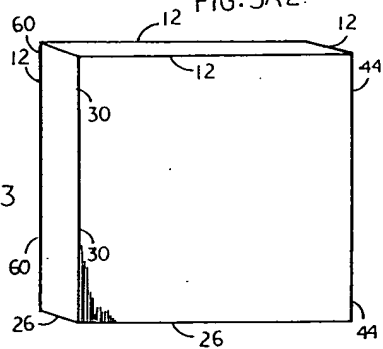

FIG. 3A3

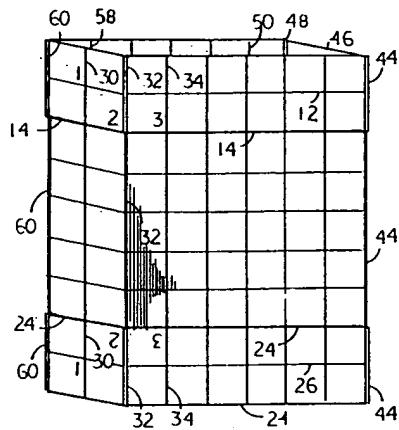

FIG. 3B1

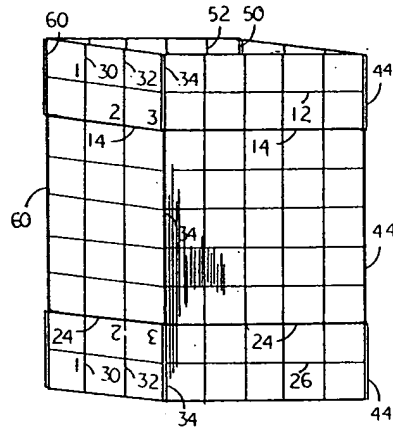

FIG. 3C1

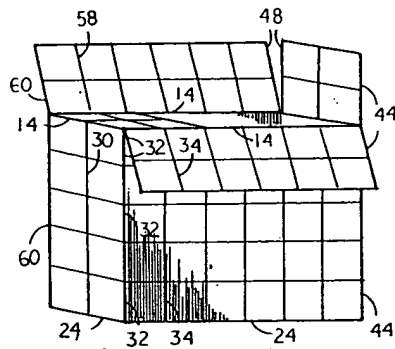

FIG. 3B2

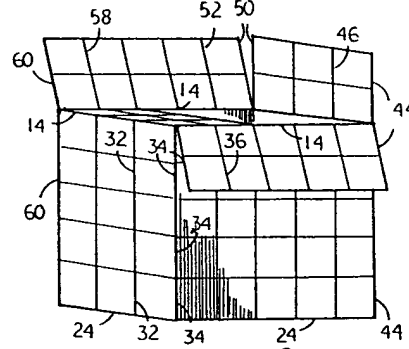

FIG. 3C2

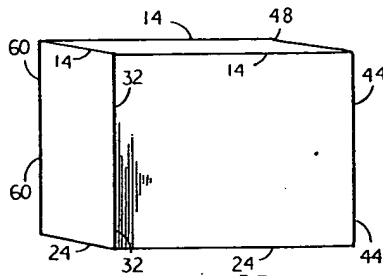

FIG. 3B3

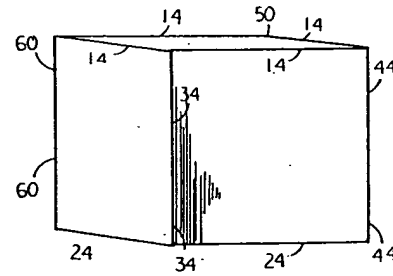

FIG. 3C3

5 BOX DESIGN

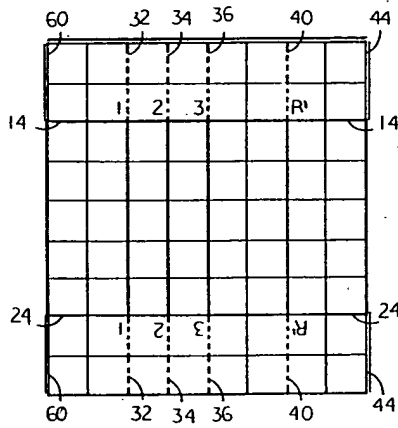

FIG. 6

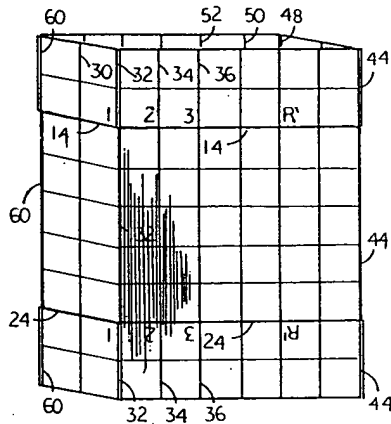

FIG. 6A1

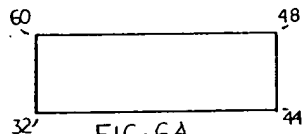

FIG. 6A

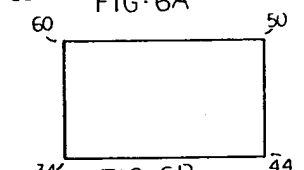

FIG. 6B

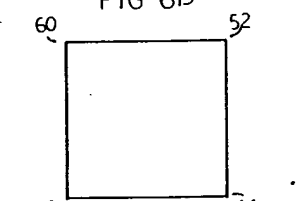

FIG. 6C

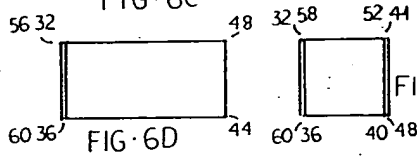

FIG. 6D

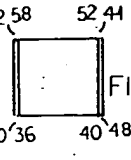

FIG. 6E

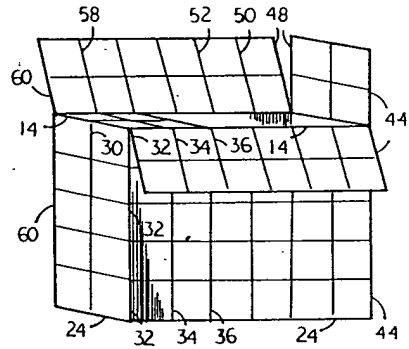

FIG. 6A2

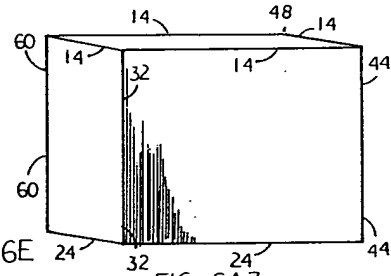

FIG. 6A3

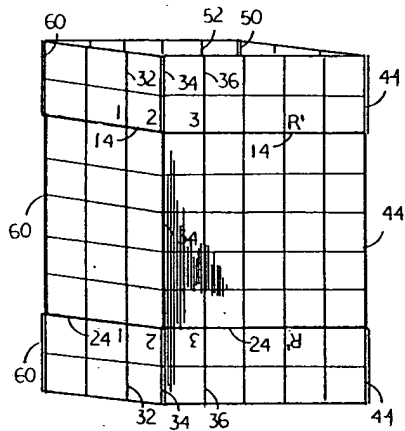

FIG. 6B1

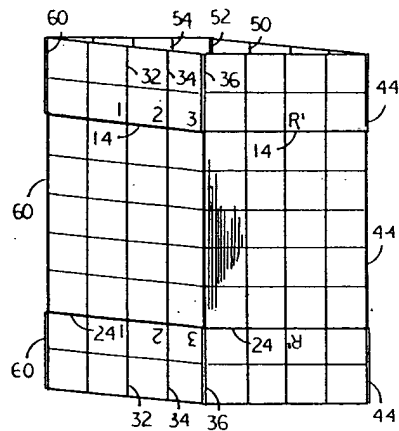

FIG. 6C1

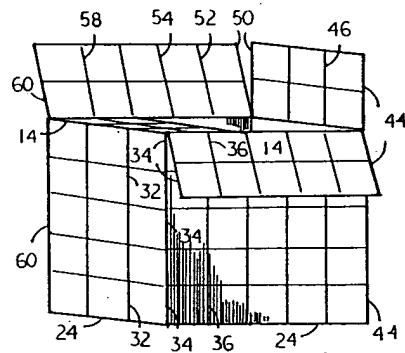

FIG. 6B2

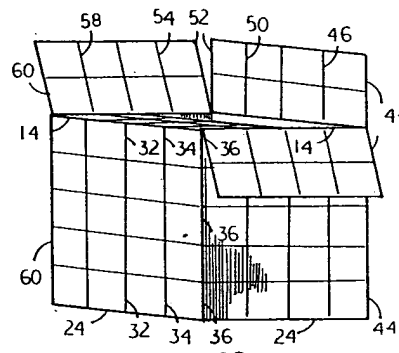

FIG. 6C2

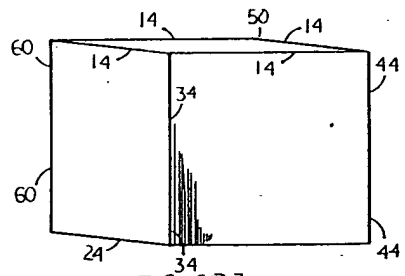

FIG. 6B3

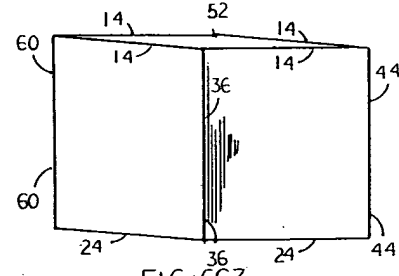

FIG. 6C3



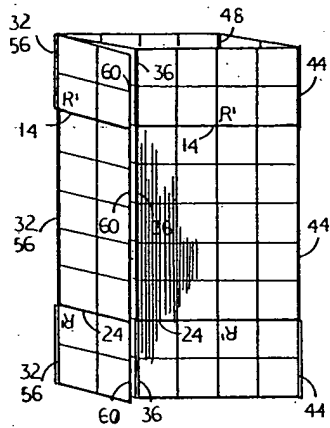

FIG. 6D1

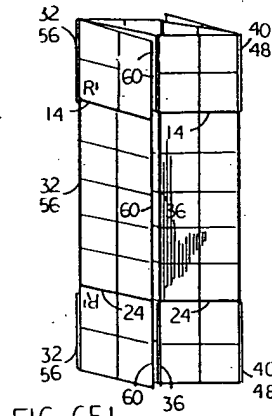

FIG. 6E1

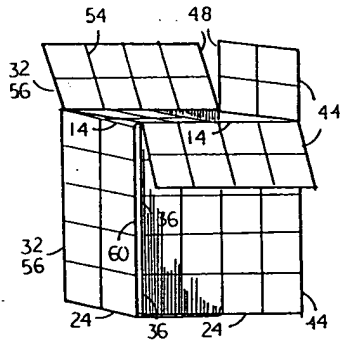

FIG. 6D2

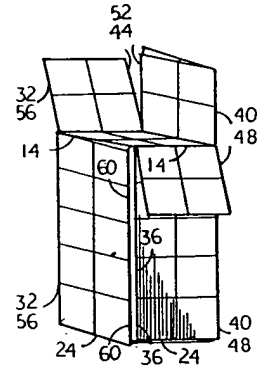

FIG. 6E2

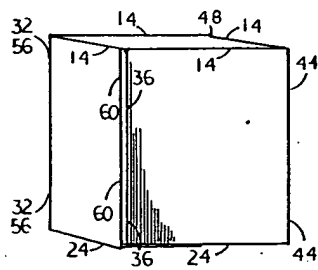

FIG. 6D3

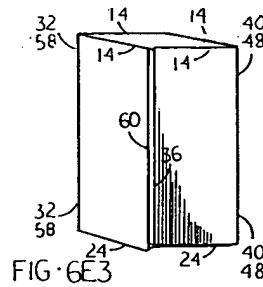

FIG. 6E3

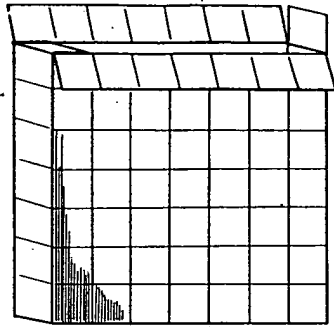

FIG-11A

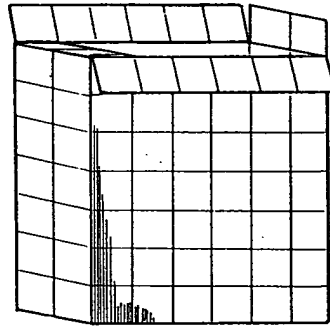

FIG-11B

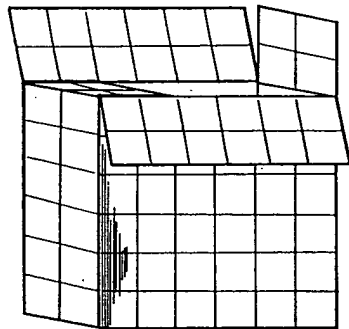

FIG-11C

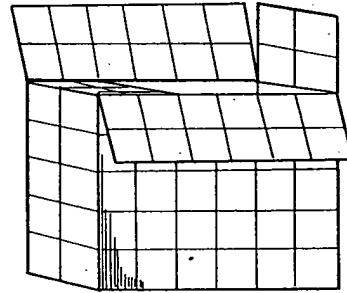

FIG-11D

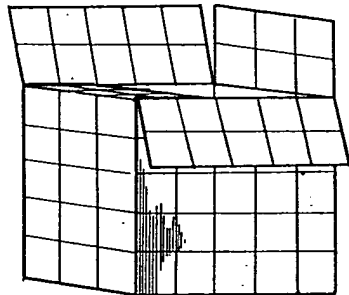

FIG-11E

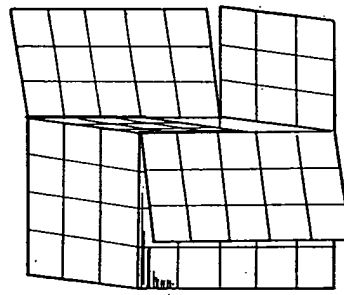

FIG-11F

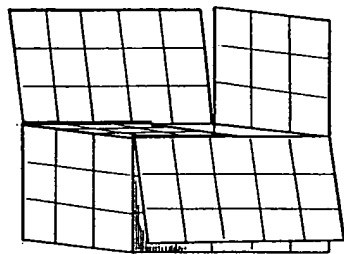

FIG-1IG

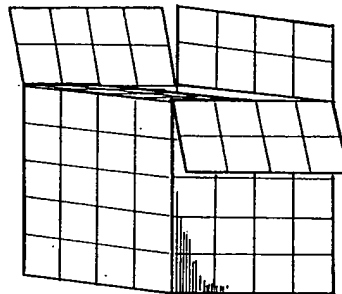

FIG-1IH

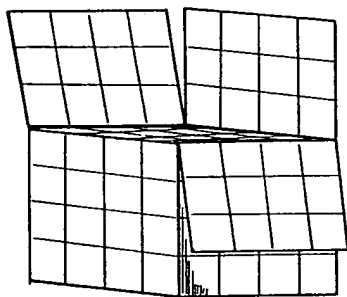

FIG-1II

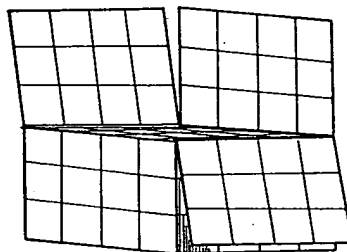

FIG-1IJ

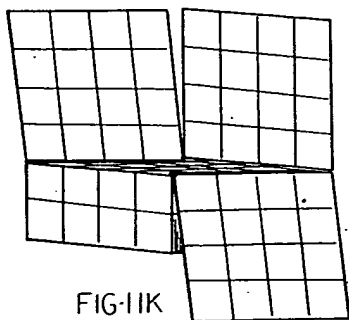

FIG-1IK

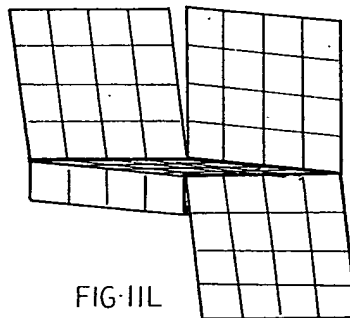

FIG-1IL

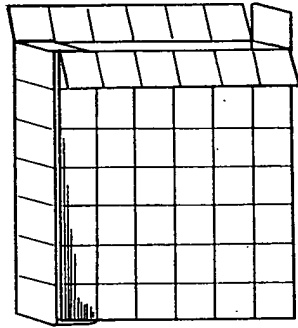

FIG-11M

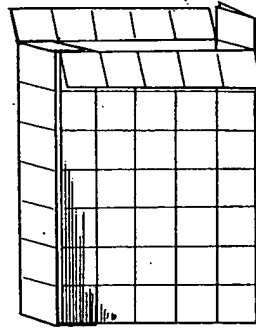

FIG-11N

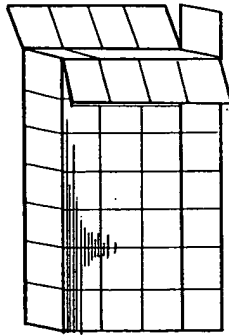

FIG-11O

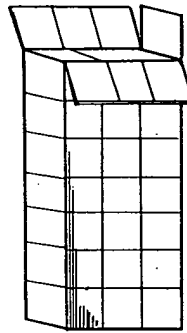

FIG-11P

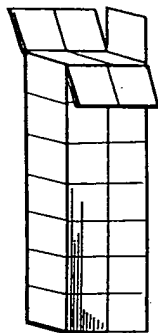

FIG-11Q

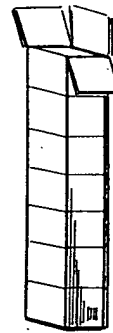

FIG-11R

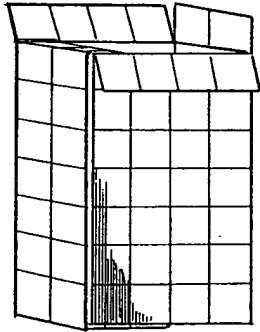

FIG-11S

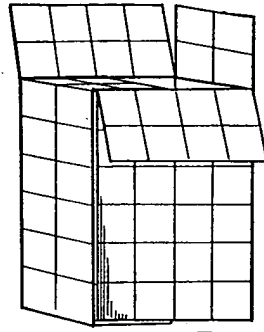

FIG-11T

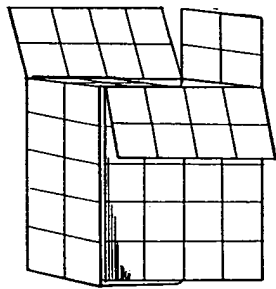

FIG-11U

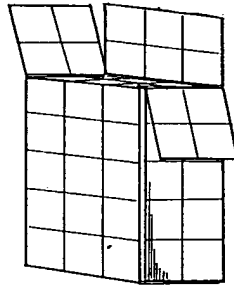

FIG-11V

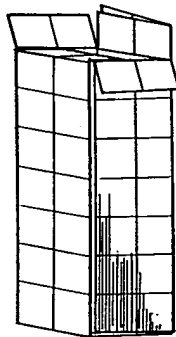

FIG-11W

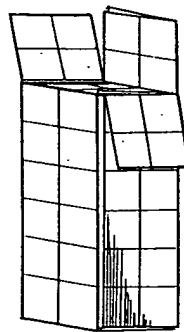

FIG-11X

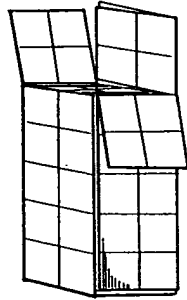

FIG. ILY